

# ZAXIS48U



Shown equipped with 1.69 m arm, additional counterweight, armrests, extra piping and pedal as optional items.

## HYDRAULIC EXCAVATOR

Model Code : ZX48U-5A

Engine Rated Power : 28.2 kW (37.8 HP)

Operating Weight : Canopy 4 450 - 4 620 kg

Cab 4 580 - 4 750 kg

Backhoe Bucket : ISO Heaped : 0.13 m<sup>3</sup>

Shown equipped with 1.69 m arm, additional counterweight, extra piping and cab as optional items.

# Trustworthy and User-Friendly New Compact Excavators

The new series of Hitachi compact excavators has evolved even more. We listen to customers' needs, provide solutions, and adopt fresh ideas into our new products.

The outcome is new excavators that are compact, productive and nimble.

The round body is smart and its wide-opening covers provide direct access to service points for quick maintenance.

The operator station is full of easy-to-use controls, an informative multi-monitor, and comfortable operator seat. A low fuel consumption design ensures better fuel efficiency.



# ZAXIS Empower your Vision.

## HIGH PERFORMANCE

- Swift actions in narrow work place
- Excellent controllability
- Reduced fuel consumption

## OPERATOR COMFORT

- Pleasant operator environment
- Sturdy operator stations by rigorous safety standards
- Easy-to-read multi-monitor

## SIMPLIFIED MAINTENANCE

- Open-wide covers for easy maintenance
- Easy-to-clean cab floor
- Sloped track frame tops for easy mud removal

## DURABILITY

- A line of Hitachi quality products
- Strong front attachment
- Rugged box-section blade
- Sturdy upperstructure



Shown equipped with 1.69 m arm, extra piping, additional counterweight, armrests, and auxiliary function lever as optional items.

Shown equipped with 1.69 m arm, extra piping, additional counterweight, armrests, and auxiliary function lever as optional items.

Notes: Standard and optional equipment may vary by country, so please consult your Hitachi dealer for details.

# HIGH PERFORMANCE

## Agility Stands for Efficiency

### Swift Actions in Narrow Work Place

Short rear-end swing design allows for safe, confident operation in tight work areas.



Shown equipped with 1.69m arm, extra piping, and additional counterweight as optional items.



### Excellent Controllability

The Hitachi pilot control system is impressive. The control lever provides excellent fine control and low-effort handling to reduce operator fatigue. It is ergonomically positioned for easy operation. The HHH (Hitachi High-performance Hydraulic) system allows for smooth operation by lever control regardless of the load. The multi-monitor allows selection of ECO and PWR modes to control the motion speed. With the engine control dial, you can also adjust engine speed with ease. The auto speed change system shifts down travel speed when the load exceeds a certain limit (for instance, when going downhill), and shifts up when the load is less.



Shown equipped with auxiliary function lever and cab as optional items.





### Reduced Fuel Consumption

A new engine has an electronic governor that is a clue to low fuel consumption. With an electronic accelerator, you can achieve precision engine control for fuel economy. To conserve fuel, select ECO mode, and to get more power, select PWR mode. In short, you can choose an optimum mode according to job needs.

The Auto Idle helps save fuel consumption, too. When moving the control lever to neutral, the Auto Idle automatically reduces engine speed to idling level four seconds later, reducing fuel consumption.

Shown equipped with 1.69 m arm, extra piping and armrests as optional items.

# OPERATOR COMFORT

Comfortable Operator Stations to Yield High Production



Shown equipped with cab, suspension seat, armrests, FM/AM radio, auxiliary function lever, air conditioner and pedal as optional items.

## Pleasant Operator Environment

Hitachi cabs and canopies have been traditionally praised for operator comfort. They are spacious with ample leg room. The console and seat are designed ergonomically, standing for operator comfort.

When sitting in the operator station, the operator will not feel restricted. Cab door width increases by 80 mm for easy access and a better view of work place. The front windshield is enlarged for higher visibility. The foot step is lowered for easy access. A host of devices, including arm rests, drink holder and seat back box, enhance operator comfort.

## Sturdy Operator Stations by Rigorous Safety Standards

The rugged cab and 4-pillar canopy well protect the operator in case of tipping. They are ruggedly designed by the ROPS\* standard. All the models are protected with the OPG\*\* top guard against falling objects.

A seat belt, pilot control shut-off lever, swing parking brake and travel parking brake are all standard. The neutral engine start system further enhances safe operation, disabling engine starting unless the lever is in lock position.

\*Roll-Over Protection Structure

\*\*Operator Protection Guard



Shown equipped with armrests, FM/AM radio, cab, air conditioner, pedal, spare power supply and suspension seat as optional items.

### Easy-to-Read Multi-Monitor

The multi-monitor is bright, informative and easy-to-read, displaying machine conditions, settings and warnings. A clock is newly added.

- 1 Menu/Return Switch**
- 2 Auto-Idle Selector Switch**
- 3 ECO/PWR Mode Selector Switch**

#### Items

- Coolant Temperature Gauge
- Fuel Gauge
- Hour Meter
- Clock
- Travel Mode Indicator
- Work Light Indicator
- Overheat Indicator
- Engine Oil Pressure Indicator
- Preheat Indicator
- Fuel Level Indicator



Shown equipped with armrests, air conditioner, cab and spare power supply as optional items.

# SIMPLIFIED MAINTENANCE

Easy Servicing, Day-in Day-out

## Open-Wide Covers for Easy Maintenance

All covers are wide-opening for direct access to service points, allowing for quick daily inspection and replacement. A cover adjacent to the radiator extends vertically to easily clean the radiator. A refueling port is placed inside the cover to avoid dirt entry and fuel theft.

A new tank cover is lightweight and wide-opening for easy refueling. A large tool box is located beside the operator seat to store a grease gun and the likes. All this increases uptime.

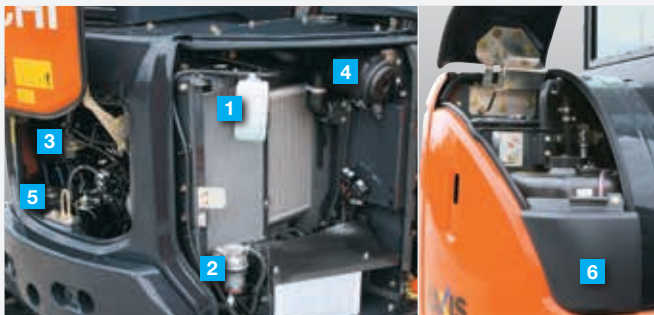

- 1 Reserve tank
- 2 Water separator
- 3 Fuel filter
- 4 Air filter
- 5 Engine oil filter
- 6 Fuel tank



Shown equipped with cab and additional counterweight as optional items.

## Easy-to-Clean Cab Floor

The radiator and oil cooler are arranged in parallel, instead of conventional in-line arrangement, to promote easy, efficient cleaning and cooling. Their wavy fins can be easily cleaned by air blowing.

Dust-proof indoor nets provide for easy removal of debris and dirt. A split-type floor mat can easily be removed at a seam between foot pedals and cab floor, and its surface patterns allow for quick sweeping.



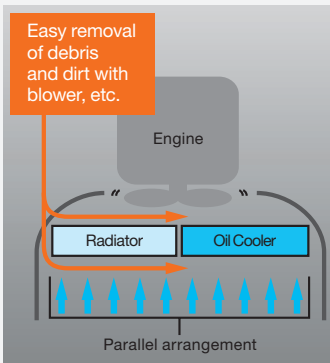

Parallel arrangement of radiator and oil cooler

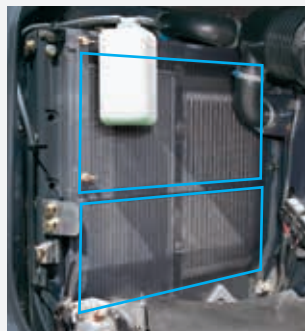

Dust-proof indoor net (optional)



Split-type floor mat

### Sloped Track Frame Tops for Easy Mud Removal

Track frame tops are sloped to let mud slide away, curbing mud packing.

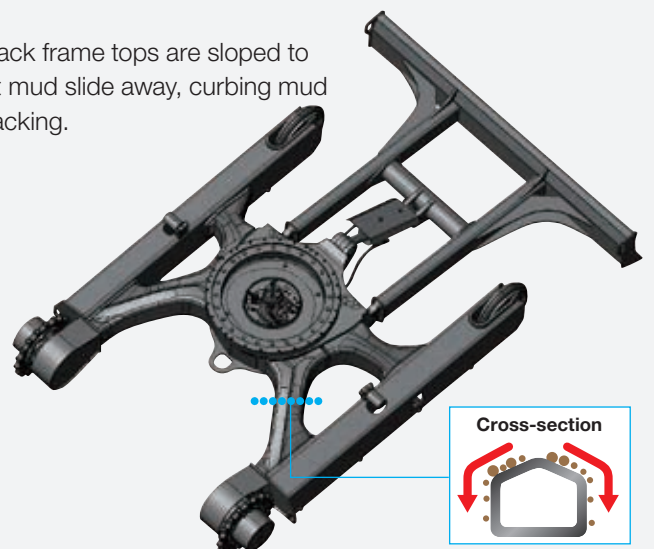

# DURABILITY

## Technological Prowess and Stringent Quality Control

### A Line of Hitachi Quality Products

Hitachi has been acclaimed worldwide for technological prowess and high-performance products since the launch of its first hydraulic excavator in 1949. Its Design Division has adopted the 3D-CAD system for applied analysis and data crunching to churn out quality products and slash lead time in development.

Newly developed products have been vigorously tested in multiple ways, such as long-hours durability test and evaluation test, at a Hitachi vast 427 hectares test field under critical operating conditions – for instance, tropical or freezing weather -- before unveiling new products.



### Strong Front Attachment

Front pins are jointed with a tight fit to reduce jerking and noise significantly, enhancing durability. Those pins are lubricated with HN bushings having an abundant grease-retaining capacity, extending greasing intervals up to 500 hours.

Main hoses are sheathed with hose protectors at the swing post. The bottom side of the boom cylinder is protected with a V-shaped boom cylinder guard. The four-side reinforced arm is sturdy with high rigidity.



Shown equipped with 1.69 m arm, additional counterweight, cab and extra piping as optional items.

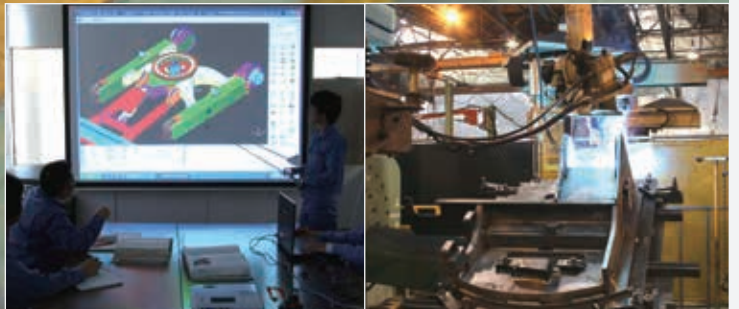

### Rugged Box-Section Blade

The blade is box-section structure for higher ruggedness, and its stays have openings for easy flow-out of mud.

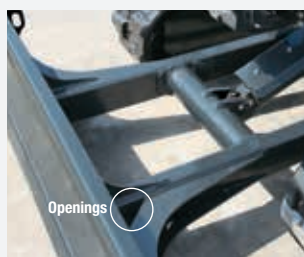

Box-section blade

### Sturdy Upperstructure

The upperstructure frame is reinforced with job-proven D-section skirts whose height is increased for larger cross section to boost durability against obstacles.



D-section frame skirt



Shown equipped with 1.69 m arm, additional counterweight, cab and extra piping as optional items.

# SPECIFICATIONS

## ENGINE

Model .....	Yanmar 4TNV88
Type .....	4-cycle water-cooled, direct injection
No. of cylinders .....	4
Rated power	
ISO 9249, net .....	28.2 kW (37.8 HP) at 2 400 min <sup>-1</sup> (rpm)
EEC 80/1269, net .....	28.2 kW (37.8 HP) at 2 400 min <sup>-1</sup> (rpm)
SAE J1349, net .....	28.2 kW (37.8 HP) at 2 400 min <sup>-1</sup> (rpm)
Maximum torque .....	139.6 Nm (14.2 kgfm) at 1 100 min <sup>-1</sup> (rpm)
Piston displacement .....	2.189 L
Bore and stroke .....	88 mm x 90 mm
Batteries .....	1 x 12 V / 72 Ah

## HYDRAULIC SYSTEM

### Hydraulic Pumps

Main pumps .....	1 variable displacement axial piston pumps
Maximum oil flow .....	1 x 120 L/min
Pilot pump .....	1 gear pump
Maximum oil flow .....	12.0 L/min

### Hydraulic Motors

Travel .....	2 variable displacement axial piston motors
Swing .....	1 axial piston motor

### Relief Valve Settings

Implement circuit .....	24.5 MPa (250 kgf/cm <sup>2</sup> )
Swing circuit .....	18.3 MPa (187 kgf/cm <sup>2</sup> )
Travel circuit .....	24.5 MPa (250 kgf/cm <sup>2</sup> )
Pilot circuit .....	5.9 MPa (60.2 kgf/cm <sup>2</sup> )

### Hydraulic Cylinders

	Quantity	Bore	Rod diameter	Stroke
Boom	1	90 mm	55 mm	699 mm
Arm	1	80 mm	50 mm	698 mm
Bucket	1	70 mm	40 mm	551 mm
Blade	1	105 mm	50 mm	140 mm
Boom swing	1	90 mm	50 mm	666 mm

## UPPERSTRUCTURE

### Revolving Frame

D-section frame for resistance to deformation.

### Swing Device

Axial piston motor with planetary reduction gear is bathed in oil. Swing circle is single-row. Swing parking brake is spring-set/hydraulic-released disc type.

Swing speed .....	9.0 min <sup>-1</sup> (rpm)
Swing torque .....	8.6 kNm (877 kgfm)

### Operator's Cab

Independent spacious cab, 1 049 mm wide by 1 611 mm high, conforming to ISO\* Standards. Reinforced glass windows on 4 sides for visibility. Front windows (upper and lower) can be opened. Reclining seat.

\* International Organization for Standardization

## UNDERCARRIAGE

### Tracks

Tractor-type undercarriage. Welded track frame using selected materials. Side frame welded to track frame.

### Numbers of Rollers on Each Side

Upper roller .....	1
Lower rollers .....	4

### Travel Device

Each track driven by 2-speed axial piston motor. Parking brake is spring-set/hydraulic-released disc type. Automatic transmission system: High-Low.

Travel speeds .....	High : 0 to 4.2 km/h
	Low : 0 to 2.5 km/h

Maximum traction force 38.3 kN (3 905 kgf)

Gradeability .....

58% (30 degree) continuous

## SERVICE REFILL CAPACITIES

Fuel tank .....	70.0 L
Engine coolant .....	4.7 L
Engine oil .....	8.6 L
Travel device (each side) .....	0.9 L
Hydraulic system .....	66.0 L
Hydraulic oil tank .....	42.0 L

## WEIGHTS AND GROUND PRESSURE

### Operating Weight and Ground Pressure

#### 4-PILLAR CANOPY

Shoe type	Shoe width	Arm length	kg	kPa (kgf/cm <sup>2</sup> )
Rubber shoe	400 mm	1.38 m	4 450	26 (0.26)
		1.69 m	4 660*	27 (0.27)*
Grouser shoe	400 mm	1.38 m	4 560	26 (0.27)
		1.69 m	4 770*	27 (0.28)*
Pad crawler shoe	400 mm	1.38 m	4 620	27 (0.27)
		1.69 m	4 830*	28 (0.28)*

Including 0.13 m<sup>3</sup> (ISO heaped), bucket weight (109 kg) .

\* Including 0.10 m<sup>3</sup> (ISO heaped), bucket weight (96 kg), additional counterweight (200 kg).

#### CAB

Shoe type	Shoe width	Arm length	kg	kPa (kgf/cm <sup>2</sup> )
Rubber shoe	400 mm	1.38 m	4 580	26 (0.27)
		1.69 m	4 790*	27 (0.28)*
Grouser shoe	400 mm	1.38 m	4 690	27 (0.28)
		1.69 m	4 900*	28 (0.29)*
Pad crawler shoe	400 mm	1.38 m	4 750	27 (0.28)
		1.69 m	4 960*	29 (0.29)*

Including 0.13 m<sup>3</sup> (ISO heaped), bucket weight (109 kg) .

\* Including 0.10 m<sup>3</sup> (ISO heaped), bucket weight (96 kg), additional counterweight (200 kg).

## BUCKET AND ARM DIGGING FORCE

Arm length	1.38 m	1.69 m
Bucket digging force ISO	32.1 kN (3 270 kgf)	
Bucket digging force SAE : PCSA	27.9 kN (2 850 kgf)	
Arm crowd force ISO	24.0 kN (2 450 kgf)	21.0 kN (2 140 kgf)
Arm crowd force SAE : PCSA	22.8 kN (2 330 kgf)	20.1 kN (2 050 kgf)

# SPECIFICATIONS

## WORKING RANGES

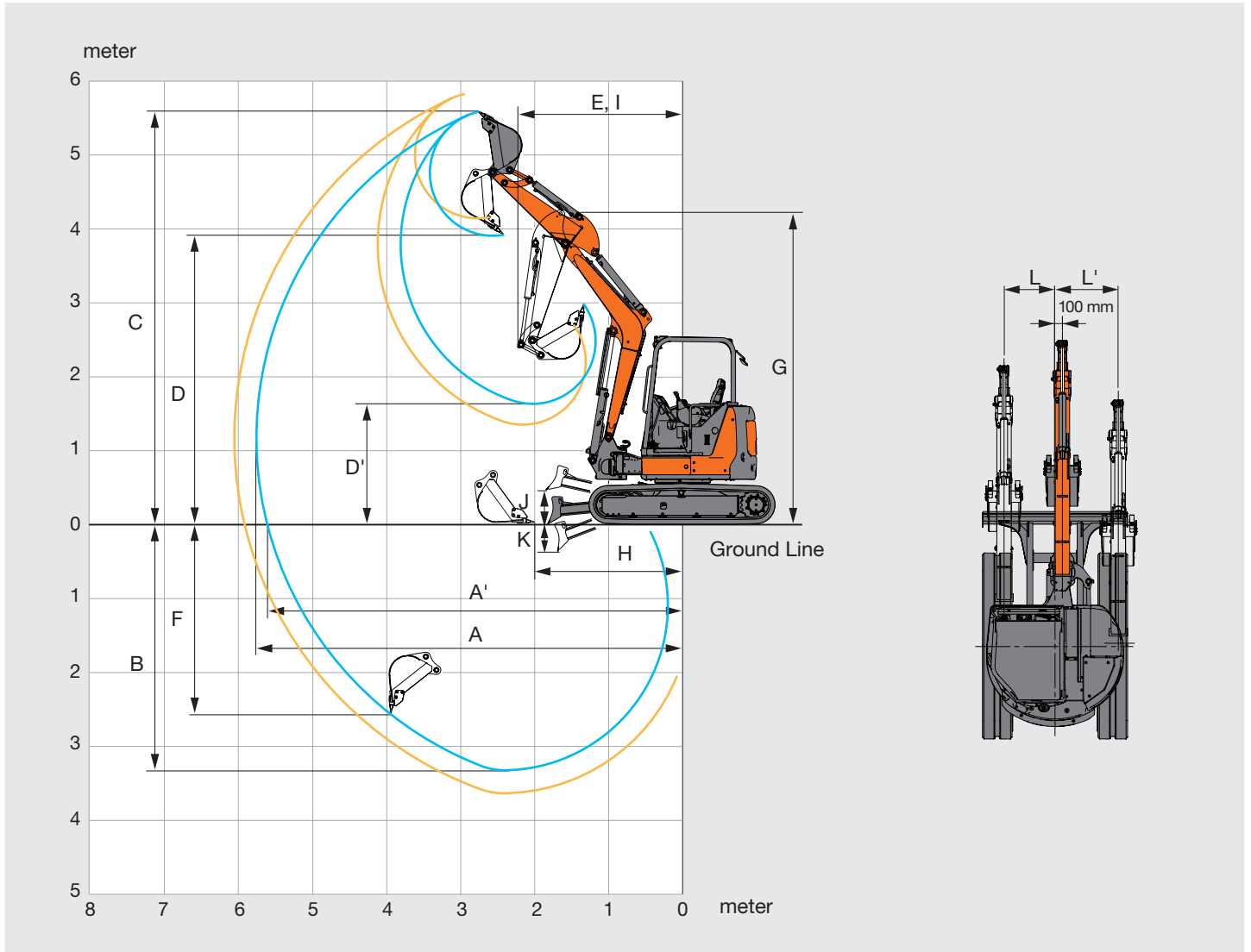

Unit: mm

Arm length	1.38 m	1.69 m
A Max. digging reach	5 760	6 060
A' Max. digging reach (on ground)	5 610	5 920
B Max. digging depth	3 320	3 630
C Max. cutting height	5 590	5 820
D Max. dumping height	3 910	4 140
D' Min. dumping height	1 630	1 350
E Min. swing radius	2 240	2 370
F Max. vertical wall digging depth	2 550	2 880
G Front height at Min. swing radius	4 250	4 250
H Min. level crowding distance	2 000	1 870
I Working radius at Min. swing radius (Max. boom-swing angle)	1 750	1 860
J Blade bottom highest position above ground	460	460
K Blade bottom lowest position above ground	365	365
L/L' Offset distance (Max. boom-swing angle)	690 / 850	690 / 850
Max. boom-swing angle (deg.)	80 / 60	80 / 60

Excluding track shoe lug.

## DIMENSIONS

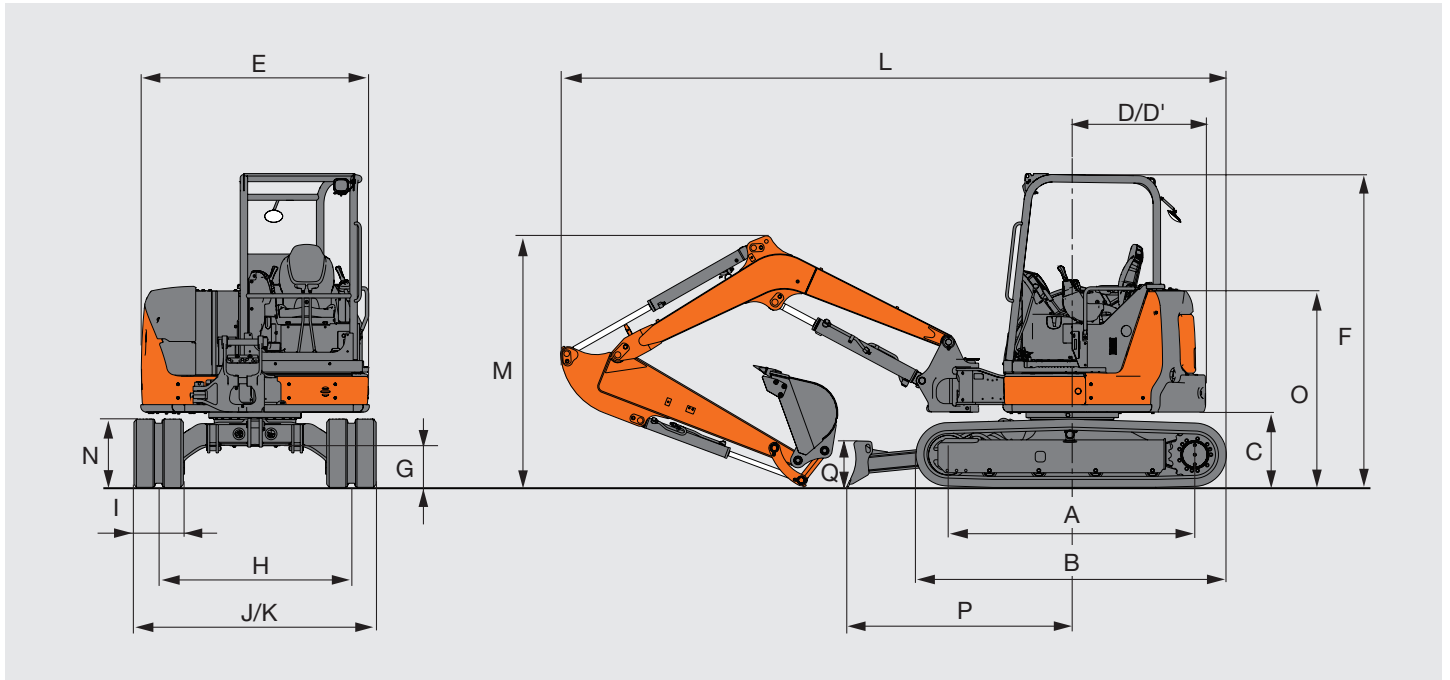

Unit: mm













	ZX48U-5A
A Distance between tumblers	2 000 (1 990)
B Undercarriage length	2 500 (2 490)
* C Counterweight clearance	610 (590)
D Rear-end swing radius	980 (1 080 with additional counterweight)
D' Rear-end length	1 080
E Overall width of upperstructure	1 850
F Overall height of cab	2 530
* G Min. ground clearance	340 (320)
H Track gauge	1 560
I Track shoe width	400
J Undercarriage width	1 960
K Overall width (Blade width)	1 960
L Overall length	
With 1.38 m arm	5 350
With 1.69 m arm	5 390
* M Overall height of boom	
With 1.38 m arm	1 840
With 1.69 m arm	2 035
N Track height	550 (530)
O Engine cover-height	1 590 (1 570)
P Horizontal distance to blade	1 820
Q Blade height	375

\* Excluding track shoe lug      Data in ( ) are dimensions of grouser shoe.

# LIFTING CAPACITIES (Without Bucket)













## ZX48U-5A 4-Pillar Canopy Version, Blade above Ground

 Rating over-front  Rating over-side or 360 degrees Unit: 1 000 kg

Conditions	Load point height m	Load radius										At max. reach		
		1.0 m		2.0 m		3.0 m		4.0 m		5.0 m				meter
														
Boom 2.68 m	3							0.97	0.79			0.71	0.58	4.80
Arm 1.69 m	2					*1.44	1.18	0.94	0.76	0.66	0.53	0.63	0.51	5.13
Additional counterweight 200 kg	1					1.39	1.09	0.90	0.72	0.64	0.52	0.60	0.49	5.21
Rubber shoe 400 mm	0 (Ground)					1.34	1.04	0.87	0.69	0.63	0.51	0.63	0.50	5.04
	-1	*1.92	*1.92	*2.58	1.99	1.33	1.03	0.86	0.68			0.71	0.57	4.60
	-2			*2.63	2.04	1.35	1.05					0.97	0.77	3.76













## ZX48U-5A 4-Pillar Canopy Version, Blade on Ground

 Rating over-front  Rating over-side or 360 degrees Unit: 1 000 kg

Conditions	Load point height m	Load radius										At max. reach		
		1.0 m		2.0 m		3.0 m		4.0 m		5.0 m				meter
														
Boom 2.68 m	3							*0.98	0.79			*0.85	0.58	4.80
Arm 1.69 m	2					*1.44	1.18	*1.14	0.76	*1.01	0.53	*0.86	0.51	5.13
Additional counterweight 200 kg	1					*2.01	1.09	*1.35	0.72	*1.07	0.52	*0.92	0.49	5.21
Rubber shoe 400 mm	0 (Ground)					*2.25	1.04	*1.47	0.69	*1.08	0.51	*1.06	0.50	5.04
	-1	*1.92	*1.92	*2.58	1.99	*2.12	1.03	*1.40	0.68			*1.09	0.57	4.60
	-2			*2.63	2.04	*1.60	1.05					*1.07	0.77	3.76













## ZX48U-5A 4-Pillar Canopy Version, Blade above Ground

 Rating over-front  Rating over-side or 360 degrees Unit: 1 000 kg

Conditions	Load point height m	Load radius										At max. reach		
		1.0 m		2.0 m		3.0 m		4.0 m		5.0 m				meter
														
Boom 2.68 m	3					*1.19	1.13	0.87	0.71			0.73	0.59	4.47
Arm 1.38 m	2					1.34	1.05	0.85	0.68			0.63	0.51	4.83
Rubber shoe 400 mm	1					1.25	0.97	0.81	0.65			0.60	0.48	4.91
	0 (Ground)					1.21	0.94	0.79	0.63			0.63	0.50	4.73
	-1			2.53	1.83	1.21	0.94	0.79	0.63			0.73	0.58	4.25
	-2			*2.05	1.88	1.25	0.97					1.09	0.86	3.28

## ZX48U-5A 4-Pillar Canopy Version, Blade on Ground

 Rating over-front  Rating over-side or 360 degrees Unit: 1 000 kg

Conditions	Load point height m	Load radius										At max. reach		
		1.0 m		2.0 m		3.0 m		4.0 m		5.0 m				meter
														
Boom 2.68 m	3					*1.19	1.13	*1.11	0.71			*1.06	0.59	4.47
Arm 1.38 m	2					*1.66	1.05	*1.25	0.68			*1.07	0.51	4.83
Rubber shoe 400 mm	1					*2.16	0.97	*1.43	0.65			*1.14	0.48	4.91
	0 (Ground)					*2.28	0.94	*1.50	0.63			*1.17	0.50	4.73
	-1			*3.06	1.83	*2.04	0.94	*1.34	0.63			*1.19	0.58	4.25
	-2			*2.05	1.88	*1.31	0.97					*1.10	0.86	3.28



- Notes:
1. Ratings are based on ISO 10567.
  2. Lifting capacity does not exceed 75% of tipping load with the machine on firm, level ground or 87% full hydraulic capacity.
  3. The load point is the center-line of the bucket pivot mounting pin on the arm.
  4. \*Indicates load limited by hydraulic capacity.
  5. 0 m = Ground.

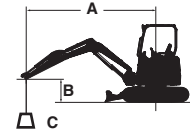

A: Load radius  
B: Load point height  
C: Lifting capacity

For lifting capacities, subtract bucket and quick hitch weight from lifting capacities without bucket.

**ZX48U-5A Cab Version, Blade above Ground**

Rating over-front Rating over-side or 360 degrees Unit: 1 000 kg

Conditions	Load point height m	Load radius										At max. reach		
		1.0 m		2.0 m		3.0 m		4.0 m		5.0 m				meter
Boom 2.68 m	3							*0.98	0.82			0.74	0.60	4.80
Arm 1.69 m	2					*1.44	1.22	0.98	0.79	0.68	0.55	0.66	0.53	5.13
Additional counterweight 200 kg	1					1.44	1.13	0.93	0.75	0.67	0.54	0.63	0.51	5.21
Rubber shoe 400 mm	0 (Ground)					1.39	1.08	0.91	0.72	0.66	0.53	0.65	0.52	5.04
	-1	*1.92	*1.92	*2.58	2.07	1.38	1.07	0.90	0.71			0.74	0.59	4.60
	-2			*2.63	2.12	1.41	1.09					1.00	0.80	3.76

**ZX48U-5A Cab Version, Blade on Ground**

Rating over-front Rating over-side or 360 degrees Unit: 1 000 kg

Conditions	Load point height m	Load radius										At max. reach		
		1.0 m		2.0 m		3.0 m		4.0 m		5.0 m				meter
Boom 2.68 m	3							*0.98	0.82			*0.85	0.60	4.80
Arm 1.69 m	2					*1.44	1.22	*1.14	0.79	*1.01	0.55	*0.86	0.53	5.13
Additional counterweight 200 kg	1					*2.01	1.13	*1.35	0.75	*1.07	0.54	*0.92	0.51	5.21
Rubber shoe 400 mm	0 (Ground)					*2.25	1.08	*1.47	0.72	*1.08	0.53	*1.06	0.52	5.04
	-1	*1.92	*1.92	*2.58	2.07	*2.12	1.07	*1.40	0.71			*1.09	0.59	4.60
	-2			*2.63	2.12	*1.60	1.09					*1.07	0.80	3.76

**ZX48U-5A Cab Version, Blade above Ground**

Rating over-front Rating over-side or 360 degrees Unit: 1 000 kg

Conditions	Load point height m	Load radius										At max. reach		
		1.0 m		2.0 m		3.0 m		4.0 m		5.0 m				meter
Boom 2.68 m	3					*1.19	1.17	0.91	0.73			0.76	0.61	4.47
Arm 1.38 m	2					1.39	1.09	0.88	0.71			0.66	0.53	4.83
Rubber shoe 400 mm	1					1.30	1.01	0.85	0.68			0.63	0.50	4.91
	0 (Ground)					1.26	0.98	0.83	0.65			0.65	0.52	4.73
	-1			2.64	1.90	1.27	0.98	0.83	0.65			0.76	0.61	4.25
	-2			*2.05	1.96	1.30	1.01					*1.10	0.89	3.28

**ZX48U-5A Cab Version, Blade on Ground**

Rating over-front Rating over-side or 360 degrees Unit: 1 000 kg

Conditions	Load point height m	Load radius										At max. reach		
		1.0 m		2.0 m		3.0 m		4.0 m		5.0 m				meter
Boom 2.68 m	3					*1.19	1.17	*1.11	0.73			*1.06	0.61	4.47
Arm 1.38 m	2					*1.66	1.09	*1.25	0.71			*1.07	0.53	4.83
Rubber shoe 400 mm	1					*2.16	1.01	*1.43	0.68			*1.14	0.50	4.91
	0 (Ground)					*2.28	0.98	*1.50	0.65			*1.17	0.52	4.73
	-1			*3.06	1.90	*2.04	0.98	*1.34	0.65			*1.19	0.61	4.25
	-2			*2.05	1.96	*1.31	1.01					*1.10	0.89	3.28

# EQUIPMENT

Standard and optional equipment may vary by country, so please consult your Hitachi dealer for details.

● : Standard equipment

○ : Optional equipment

ENGINE	
Auto idle system	●
Cartridge-type engine oil filter	●
Dust-Proof indoor net	○
Electrical fuel feed pump	●
Fuel main filter	●
Radiator reserve tank	●
Water-separator for engine fuel	●

HYDRAULIC SYSTEM	
Boom anti-drift valve	●
Full-flow filter	●
Hose rupture valve	○
Hydraulic pilot type control levers	●
Pilot control shut-off lever with neutral engine start system	●
Pilot filter	●
Suction filter	●
Swing parking brake	●
Travel parking brake	●
Two-speed travel system	●
Valve for extra piping	●

## 4-PILLAR CANOPY

Anti-slip plate	●
Armrests	○
Auxiliary function lever (AFL)	○
Drink holder	●
Electric horn	●
Floor mat	●
Reclining seat	○
Retractable seat belt	○
ROPS/OPG canopy	●
Spare power supply	○
Suspension seat	○

CAB	
Air conditioner	○
AM/FM radio	○
Anti-slip plate	●
Armrests	○
Auxiliary function lever (AFL)	○
Defroster	●
Drink holder	●
Electric horn	●
Floor mat	●
Heater	●
Reclining seat	●
Retractable seat belt	○
ROPS/OPG cab	●
Spare power supply	○
Suspension seat	○
Window washer	●
Wiper	●

UPPERSTRUCTURE	
Auxiliary overload relief valve	○

Electric fuel refilling pump	○
Pilot accumulator	○
Rear view mirror	●
Stack muffler	○
Tool box	●
200 kg additional counterweight	○

UNDERCARRIAGE	
400 mm grouser shoe	○
400 mm pad crawler shoe	○
400 mm rubber shoe	●

FRONT ATTACHMENTS	
Assist piping	○
Extra piping	○

HN bushing	●
1.38 m arm	●
1.69 m arm	○

MISCELLANEOUS	
Theft deterrent system*	○

\* Hitachi Construction Machinery cannot be held liable for theft, any system will just minimize the risk of theft.



# MEMO



**Built on the foundation of superb technological capabilities, Hitachi Construction Machinery is committed to providing leading-edge solutions and services to contribute as a reliable partner to the business of customers worldwide.**

## Hitachi Environmental Vision 2050

Our Environmental Vision envisions a low-carbon society; a resource efficient society; a harmonized society with nature. To achieve such a sustainable society, we have established a set of long-term environmental targets called Hitachi Environmental Innovation 2050.

### Reducing Environmental Impact by New ZAXIS

Hitachi makes a green way to cut carbon emissions for global warming prevention according to LCA\*. New ZAXIS utilizes lots of technological advances, including the new ECO mode, and Isochronous Control. Hitachi has long been committed to recycling of components, such as aluminum parts in radiators and oil cooler. Resin parts are marked for recycling.

\*Life Cycle Assessment – ISO 14040

These specifications are subject to change without notice. Illustrations and photos show the standard models, and may or may not include optional equipment, accessories, and all standard equipment with some differences in color and features. Before use, read and understand the Operator's Manual for proper operation.

